



Benha University

Prof. Mohamed Ahmed Ebrahim

Benha University
Faculty of Engineering at Shoubra
Electrical Engineering Dept.



Energy Storage & Transmission

By

Associate Prof. / Mohamed Ahmed Ebrahim Mohamed
Consultant of New and Renewable Energy Systems

E-mail: mohamedahmed_en@yahoo.com

mohamed.mohamed@feng.bu.edu.eg

Web site: <http://bu.edu.eg/staff/mohamedmohamed033>





Lecture (3)
01– 03 - 2020





Energy Resources

Prof. Mohamed Ahmed Ebrahim

Energy

1. Sources of Energy

- ▣ What are the major sources of energy
- ▣ How our usage of energy has changed in time?

2. Energy Use

- ▣ To what purposes energy is used for?

3. Challenges

- ▣ What major energy challenges are we facing?

Sources of Energy

1. Nature

- ▣ Energy is movement or the possibility of creating movement:
 - Exists as potential (stored) and kinetic (used) forms.
- ▣ Conversion of potential to kinetic.
- ▣ Movement states:
 - Ordered (mechanical energy) or disordered (thermal energy).
 - Temperature can be perceived as a level of disordered energy.
 - Major tendency is to move from order to disorder (entropy).

2. Importance

- ▣ Human activities are dependent on the usage of several forms and sources of energy.
- ▣ Energy demands:
 - Increased with economic development.
 - The world's power consumption is about 12 trillion watts a year, with 85% of it from fossil fuels.

Energy Use

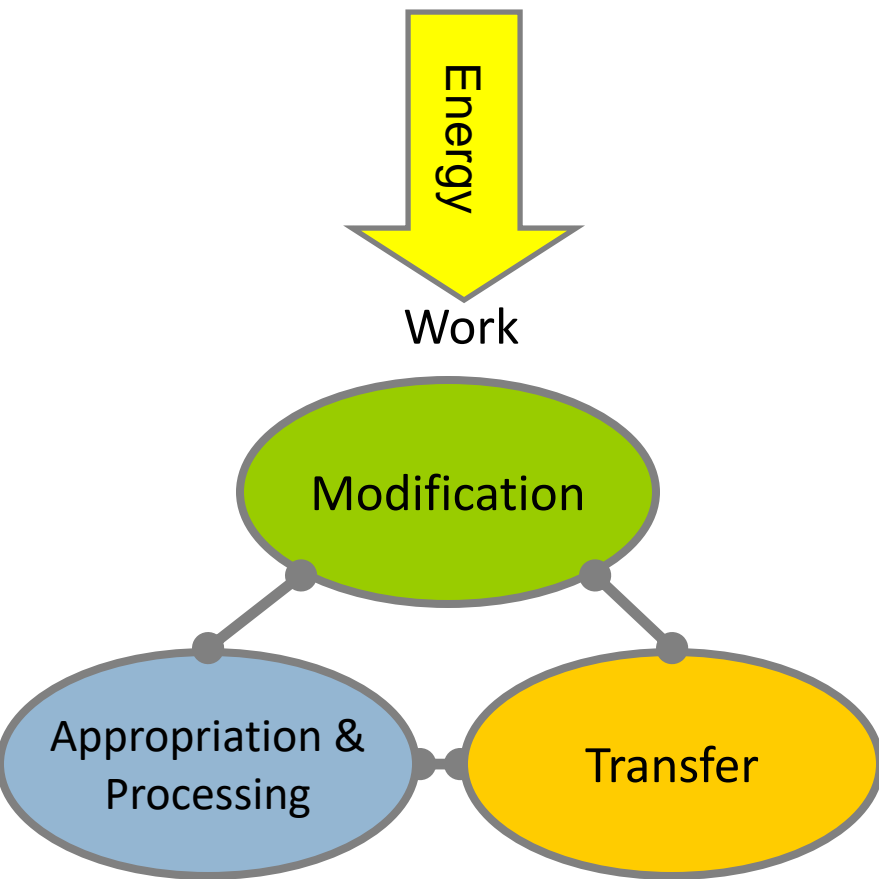

□ Energy and work

- Energy provides work.
- Technology enables to use energy more efficiently and for more purposes.
- Traditionally, most of the work was performed by people:
 - Many efforts have been done to alleviate work.
- Creating more work performed by machines and the usage of even more energy.

Challenges

1. Energy Supply

- ▣ Providing supply to sustain growth and requirements.
- ▣ A modern society depends on a stable and continuous flow of energy.

2. Energy Demand

- ▣ Generate more efficient devices:
 - Transportation.
 - Industrial processes.
 - Appliances.

3. Environment

- ▣ Provide environmentally safe sources of energy.
- ▣ Going through the energy transition (from solid to gasses).

Conventional Energy Resources

What sources of energy have filled our requirements so far?

1. Coal
2. Petroleum
3. Natural Gas
4. Hydropower
5. Nuclear Power

1. Coal

□ Nature

- Formed from decayed swamp plant matter that cannot decompose in the low-oxygen underwater environment.
- Coal was the major fuel of the early Industrial Revolution.
- High correlation between the location of coal resources and early industrial centers:
 - The Midlands of Britain.
 - Parts of Wales.
 - Pennsylvania.
 - Silesia (Poland).
 - German Ruhr Valley.
- Three grades of coal.

2. Petroleum

□ Nature

- Formation of oil deposits:
 - Decay under pressure of billions of microscopic plants in sedimentary rocks.
 - “Oil window”; 7,000 to 15,000 feet.
 - Created over the last 600 million years.
- Exploration of new sources of petroleum:
 - Related to the geologic history of an area.
 - Located in sedimentary basins.
 - About 90% of all petroleum resources have been discovered.
- Production vs. consumption:
 - Geographical differences.
 - Contributed to the political problems linked with oil supply.

Prof. Mohamed Ahmed Ebrahim

□ **Why an oil dependency?**

- ▣ Favor the usage of petroleum as the main source of energy for transport activities.
- ▣ The utility factors were so convenient that a dependency on petroleum was created.

□ **Taxes**

- ▣ Should oil be taxed?
- ▣ Should the development of alternative sources of energy be accelerated or enforced?

3. Natural Gas

□ Nature

□ Formation:

- The myogenic: converted organic material into natural gas due to high pressure.
- Deeper window than oil.
- Biogenic: transformation by microorganisms.

□ Composition:

- Composed primarily of methane and other light hydrocarbons.
- Mixture of 50 to 90% by volume of methane, propane and butane.
- “Dry” and “wet” (methane content); “sweet” and “sour” (sulfur content).

□ Usually found in association with oil:

- Formation of oil is likely to have natural gas as a by-product.
- Often a layer over the petroleum.

4. Hydropower

□ Nature

- Generation of electricity using the flow of water as the energy source.
- Gravity as source.
- Requires a large reservoir of water.
- Considered cleaner, less **polluting** than fossil fuels.

□ Tidal power

- Take advantage of the variations between high and low tides.

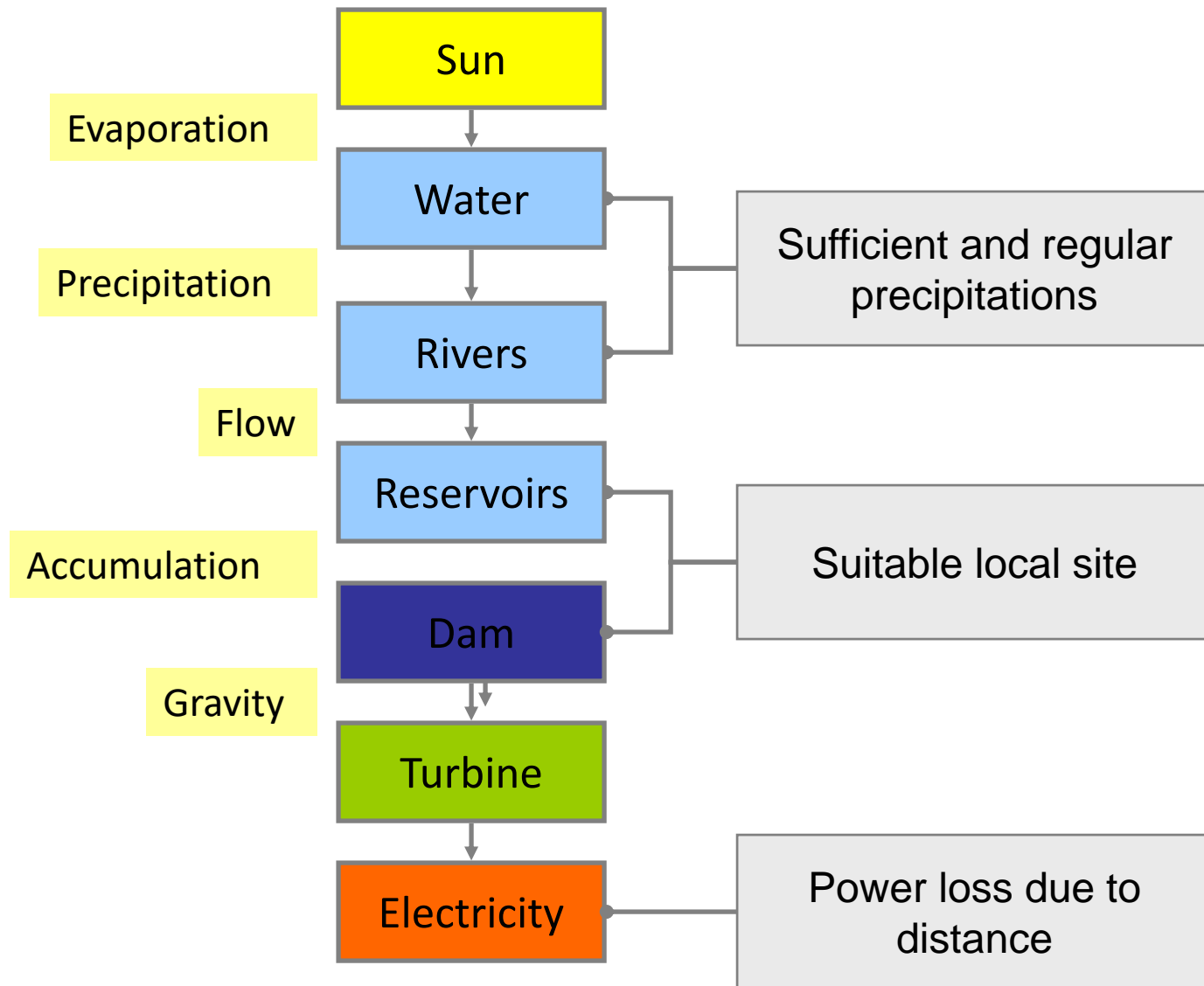

5. Nuclear Power

□ Nature

- Fission of uranium to produce energy.
- The fission of 1 kg (2.2 lb) of uranium-235 releases 18.7 million kilowatt-hours as heat.
- Heat is used to boil water and activate steam turbines.
- Uranium is fairly abundant.
- Requires massive amounts of water for cooling the reactor.

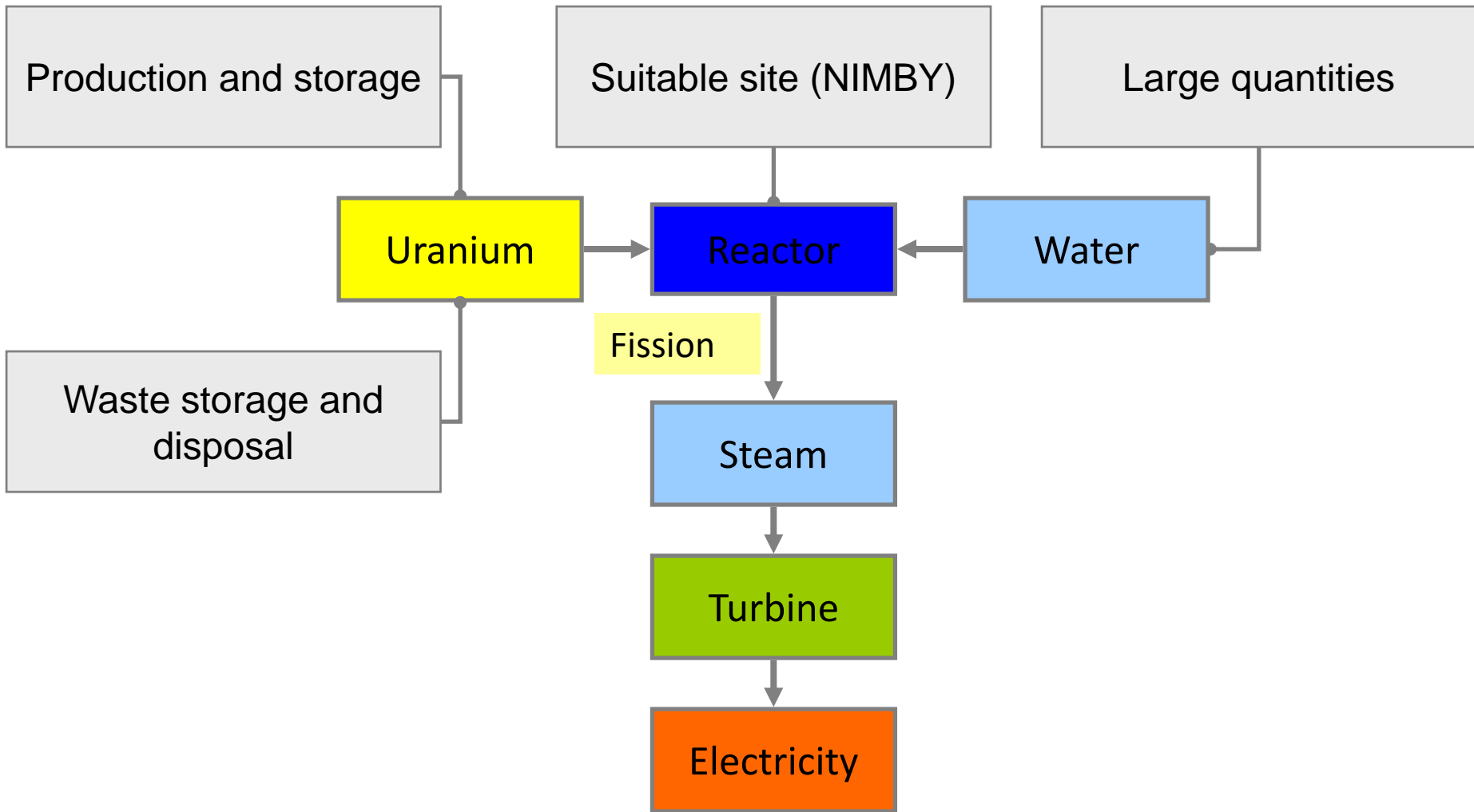

Dr : Mohamed Ahmed Ebrahim



Renewable Energy Systems

Prof. Mohamed Ahmed Ebrahim

					
Solar	Wind	Geo	Hydro	Bio	Tide

History of Renewable Energy

- Prior to the development of coal in the mid 19th century nearly all energy was renewable.
- By 1873, concerns of running out of coal promoted experiments using **Solar Energy**.
- Development of solar energies continued until the outbreak of 1st world war
- In the 1970 environmentalist promoted the development of renewable energy for replacement of oil and decreasing dependence on oil leading to the first electricity generating wind turbine.

Prof. Mohamed Ahmed Ebrahim

Continue

- 1970 energy crisis led to the establishment of the Commission For Additional Sources Of Energy (CASE) in the department of science and technology in 1981.
- In 1982, a new department was created in the Ministry of Energy Department of Non-Conventional Energy Sources (DNES).
- A decade later in 1992, DNES became Ministry of Non-Conventional Energy Sources (MNES) and in 2006 it gained its current name as Ministry of New and Renewable Energy.

Why is Renewable Energy needed?

- The world is dependent on fossil fuels for its energy supply. Currently, fossil fuels account for 80% of the world's energy consumption.
- Fossil fuels take millions of years to form and our reserves are depleting rapidly. This means that fossil fuels are non-renewable resources and society needs to find an alternative energy supply.

Continue

- There are many reasons for society to switch to renewable forms of energy will discussed:

1. **Fossil Fuels Are Limited**

2. **Renewable Energy is Better for the Environment**

Fossil fuels not only cause climate change, but are also damaging the environment through land, water and air pollution.

3. **Fossil Fuels Contribute to Climate Change**

burning fossil fuels releasing so much carbon dioxide into the earth's atmosphere is causing severe weather problems.



Continue

4. **Renewable Energy is the Future**

The non-renewable energy sources will run out and there won't be any other option. Renewable energy will never run out.

5. **Renewable Energy can be Self-Sufficient**

people are no control of their energy supply and they have no means of creating their own energy supply. With renewable energy systems, people can have complete control.



Continue

6. **Economic Stability**

In many cases, energy produced from renewable sources is already cheaper than that produced by non-renewable means.

7. **Public Health**

Few renewables are entirely emission-free, but their output is much lower than conventional fossil fuel acquisition and processing.

1. Solar Energy



Prof. Mohamed Ahmed Ebrahim

What is the solar energy?

- Most renewable energy comes either directly or indirectly from the sun.
- Sunlight, or solar energy, can be used directly for heating and lighting homes and other buildings, for generating electricity, and for hot water heating, solar cooling, and a variety of commercial and industrial uses.



Prof. Mohamed Ahmed Ebrahim

Continue

- **There are two basic technologies of solar energy**

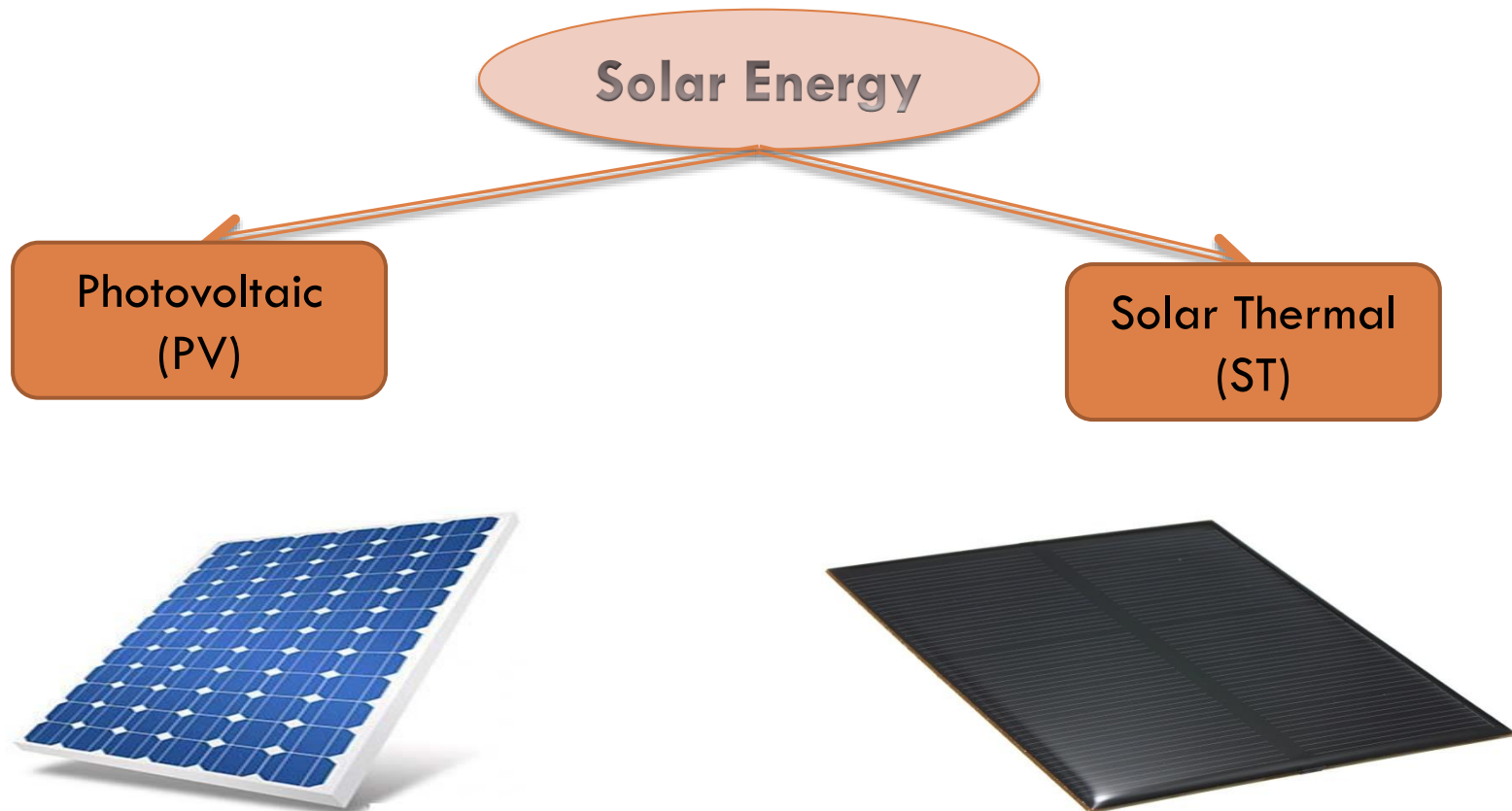

Continue

1. Photovoltaic (PV)

- These are the most common form and have always been, and now increasingly common on top of our homes, Each cell converts the light of the sun into electrical energy, which can then be used to power electrical devices.
- Solar Cell often made from semiconductors material such as silicon materials.

Continue

- **Advantages of PV solar**

1. During electricity generation with PV panels there is no harmful greenhouse gas emissions thus solar PV is environmentally friendly.
2. PV panels have no mechanically moving parts, except in cases of sun tracking mechanical bases.
3. PV panels are totally silent, producing no noise at all.
4. Photovoltaic panels produce electricity in a direct electricity generation way.
5. Operating and maintenance costs for PV panels are considered to be low compared to other renewable energies.

Continue

- **Disadvantages of PV solar**

1. Not shining at night but also during daytime there may be cloudy or rainy weather.
2. Solar energy panels require additional equipment i.e. (inverters, chargers, and batteries).
3. They are fragile and can be damaged relatively easily.

Continue

- **Applications of PV solar**

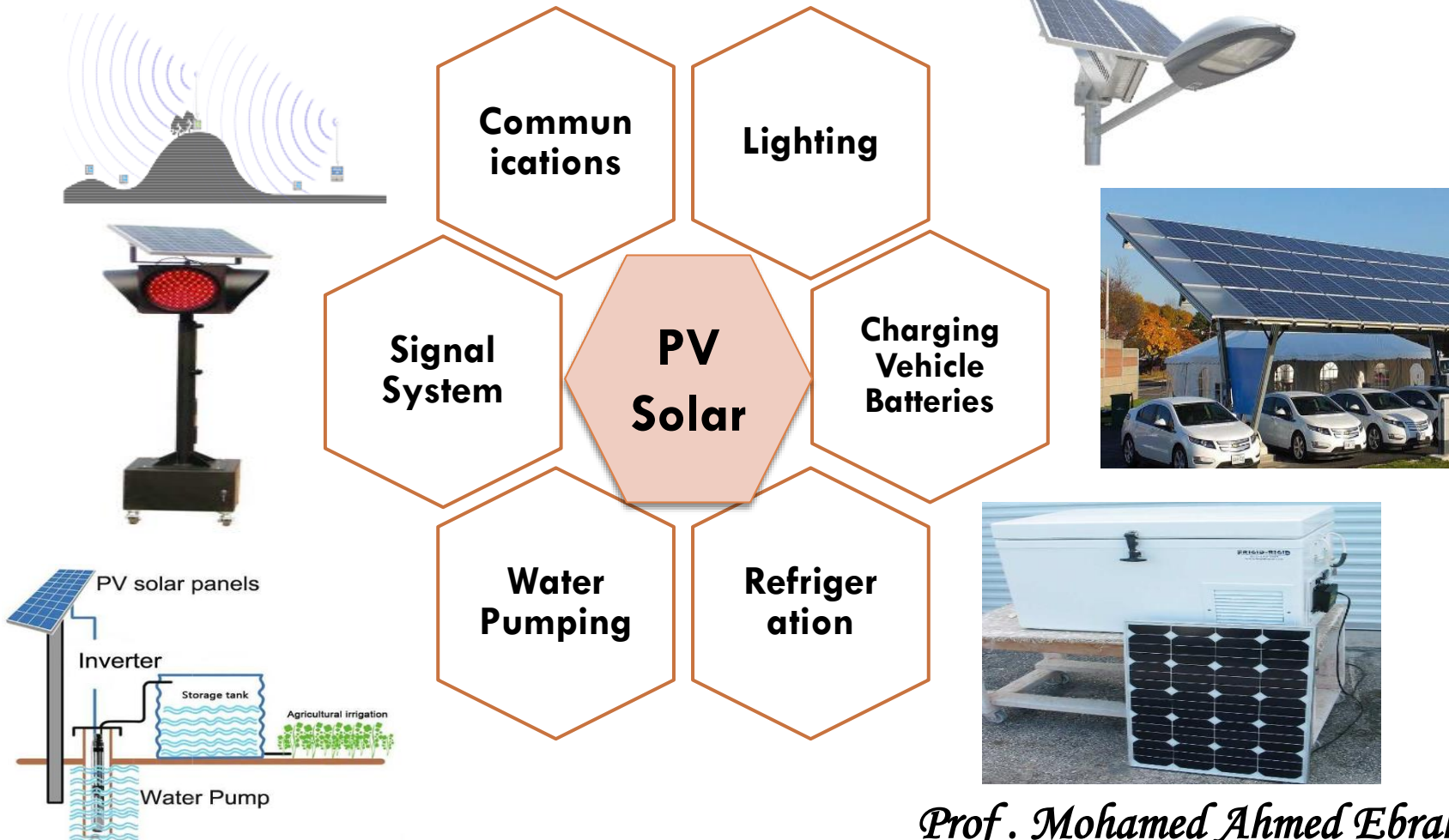

Prof. Mohamed Ahmed Ebrahim

How Solar Energy Work?

1. Photovoltaic (PV) cells convert sunlight to direct current (DC) electricity.
2. The inverter converts DC into alternating current (AC) electricity.
3. The electrical panel sends power to your lights and appliances.
4. The utility meter measures the energy you draw and feed back to the grid.

Continue

2. Solar Thermal

- This type of technology is known as Concentrated Solar Power (CSP).
- May look similar to PV, but they work differently in that they draw in a concentrated beam of sunlight, reflecting it through a system of mirrors.
- The resulting heat generated by the process activates a turbine that produces electricity through a conventional generator. Where PV produces energy from light, this produces energy from heat.

Continue

- **Advantages of Solar Thermal solar**

1. No Fuel Cost.
2. Predictable, 24/7 Power.

Solar Thermal Energy can generate power 24 hours a day. Other forms of Renewable Energy like Solar PV and Wind Energy are intermittent in nature.

3. The electricity supply is much more uniform and reliable.
4. No Pollution and Global Warming Effects.
5. Using Existing Industrial Base.

Solar Thermal Energy uses equipment like mirrors and turbines which is made in large scale at low cost.

Continue

- **Disadvantages of Solar Thermal**

1. Future Technology has a high probability of making CSP Obsolete.

2. Water Issue

Solar Thermal Plants use lots of Water which is Major Problem in Desert Areas.

3. Ecological and Cultural Issues

The Usage of Massive Arrays of Mirrors is noted to heavily impact the Desert Wildlife endangering the endangered species.

Continue

4. Limited Locations and Size Limitations

Solar Thermal Energy can only be built in places which have the high amount of solar radiation. They can be built in deserts mostly and require a large land area.

5. Long Gestation Time Leading to Cost Overruns

The Gestation Time for permitting, financing, drilling, can easily take 5-7 years to develop a concentrated solar thermal power plant. Compare this to 6 months for a small wind farm or 3 months for a Solar PV plant.

Continue

- **Applications of Solar Thermal**



Solar oven

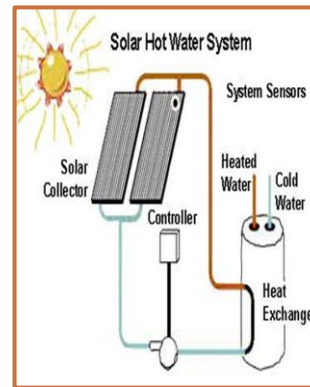

Hot Water Collector

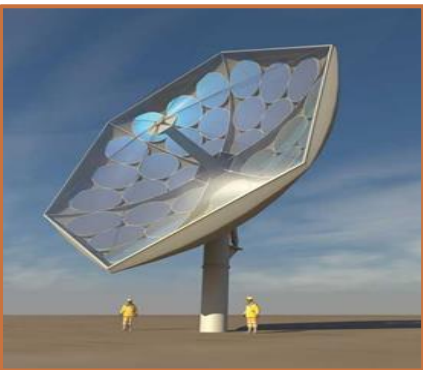

Water Desalination

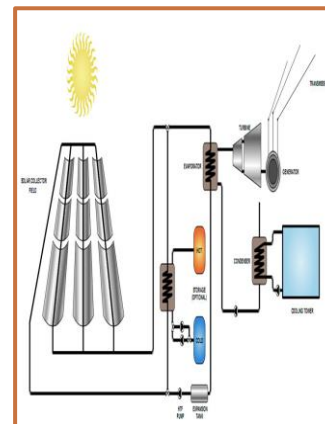

Electricity Generation

How Solar Thermal Work?

- Solar thermal technology is large-scale by comparison. One big difference from PV is that solar thermal power plants generate electricity indirectly.
- Heat from the sun's rays is collected and used to heat a fluid.
- The steam produced from the heated fluid powers a generator that produces electricity. It's similar to the way fossil fuel burning power plants work except the steam is produced by the collected heat rather than from the combustion of fossil fuels.

2. Wind Energy

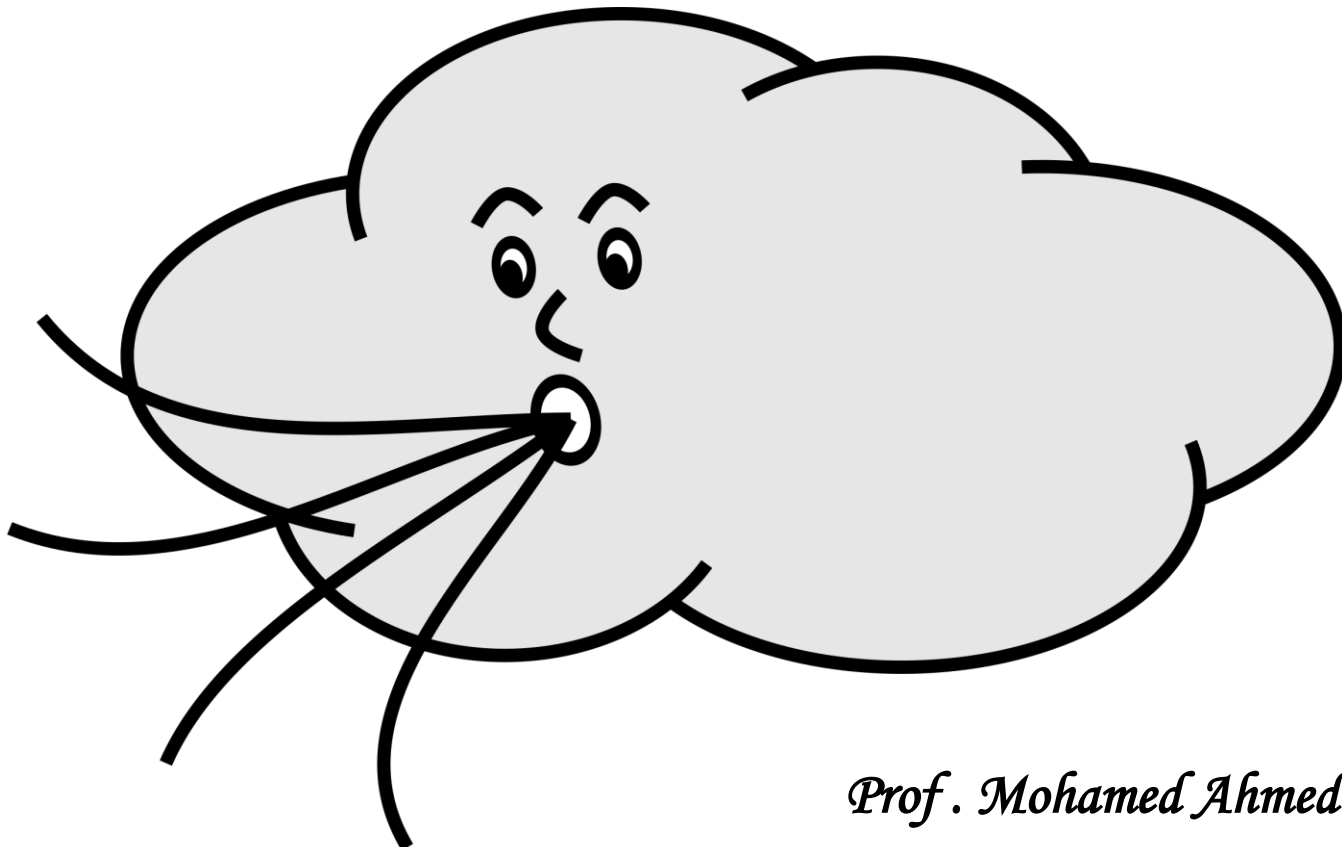

Prof. Mohamed Ahmed Ebrahim

What is the Wind energy?

- Wind is the movement of air from an area of high pressure to an area of low pressure.
- The energy of wind is harnessed with wind turbine, they are usually grouped in wind farms.
- constant, such as offshore and high altitude sites, are preferred locations of wind farm.
- Wind energy is believed to be five times total current global energy production.



Prof. Mohamed Ahmed Ebrahim

Continue

- There are three types of wind farms:
 1. Onshore farms(often near water).
 2. Nearshore farms(on land or on sea within several Km of a coast).
 3. Offshore farms(parks ten Km or more from land).

Advantages of Wind Energy

1. Wind energy is a clean fuel source, and doesn't pollute the air like power plants.
2. It is a domestic source of energy.
3. The wind is free and with modern technology it can be captured efficiently.
4. Once the wind turbine is built the energy it produces does not cause green house gases or other pollutants.
5. Although wind turbines can be very tall each takes up only a small plot of land. This means that the land below can still be used.



Continue

6. Remote areas that are not connected to the electricity power grid can use wind turbines to produce their own supply.
7. Wind turbines are available in a range of sizes which means a vast range of people and businesses can use them.

Disadvantages of Wind Energy

1. Installation is Expensive.
2. Threat to Wildlife.
3. Noise Pollution.
4. Visual Pollution.

Wind Energy Application

1. Wind turbines can be used as stand-alone applications, or they can be connected to a utility power grid or combined with a photovoltaic (solar cell) system.
2. Several electricity providers today use wind plants to supply power to their customers.
3. Stand-alone wind turbines are typically used for water pumping or communications.
4. Small wind systems also have potential as distributed energy resources.

How Wind Energy Works?

- Most wind energy comes from turbines that can be as tall as a 20-story building and have three 200-foot (60-meter)-long blades.
- The wind spins the blades, which turn a shaft connected to a generator that produces electricity.
- The biggest wind turbines generate enough electricity in a year (about 12 megawatt-hours).
- Wind farms have tens and sometimes hundreds of these turbines lined up together in particularly windy spots.
- Smaller turbines erected in a backyard can produce enough electricity for a single home or small

3. Hydropower Energy



Prof. Mohamed Ahmed Ebrahim

What is the Hydropower Energy?

- An Electrical energy created from water stored in huge dams.
- The energy created by the water released from these dams is transformed into electricity by hydro-electric turbines and generators.
- Hydropower supplies 19% of all electricity in the world.
- The most famous source of hydroelectric power is in the Snowy Mountains.
- It is less expensive than mining fossil fuels and does not contribute to the greenhouse effect

Advantages of Hydropower Energy

1. No greenhouse gases.
2. Energy generated can be increased or decreased depending on the needs of the community that uses it.
3. Hydroelectricity is one of the lowest cost forms of energy as it requires no fuel, Low Operating Costs and little Maintenance.
4. Water used is free.
5. It is one of the cleanest forms of energy.
6. Renewable Source.

Disadvantages of Hydropower Energy

1. Building a dam destroys an area of landscape and changes the ecology downstream.
2. People living in village and towns that are in the valley to be flooded, must move out.
3. Dams have endangered some species of fish (fish population).

How Hydropower Energy Works?

1. Hydropower plants capture the energy of falling water to generate electricity.
2. A turbine converts the kinetic energy of falling water into mechanical energy.
3. Then a generator converts the mechanical energy from the turbine into electrical energy, as known as **Hydropower** or **Hydroelectric power**.

Hydropower Energy Application

- **Applications of Hydropower**

1. **Electricity generation.**

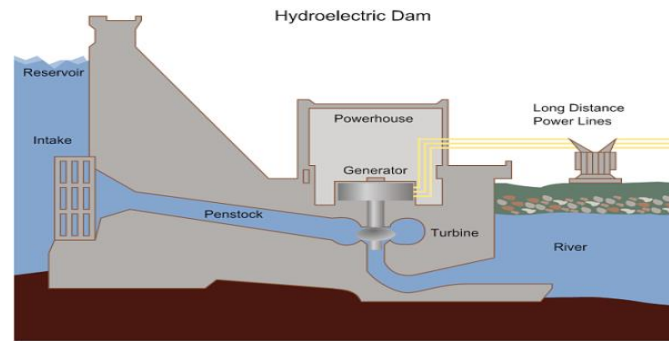

2. **Energy Storage**

The main use of Pumped Hydro Storage is for Grid Energy Storage. Electric Utilities are the main customers of this Technology using

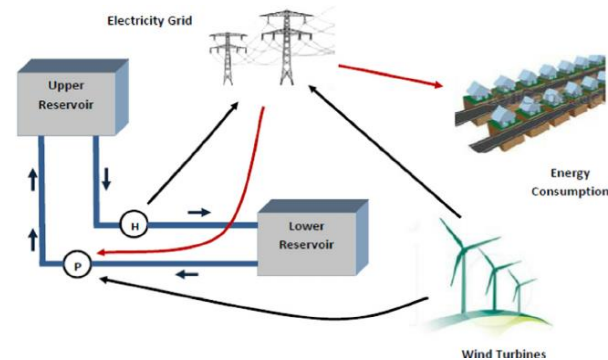

Prof. Mohamed Ahmed Ebrahim



Continue

3. **Agriculture**

Hydropower was used in ancient times for producing flour from grain and was also used for sawing timber and stone, raised water into irrigation canals.

4. **Industry**

Hydropower was used earlier for some industrial applications such as driving the bellows in small blast furnaces and for extraction of metal ores in a method known as hushing.

4. **Geothermal Energy**

Geothermal



Prof. Mohamed Ahmed Ebrahim

What is the Geothermal Energy?

- Energy from the heat of the earth. It has been used for thousands of years in some countries for hot water, cooking and heating.
- It can also generate electricity using steam produced from heat found beneath the surface of the earth.
- It is not common yet though experimental and pilot geothermal power generation is being explored.
- Several meters under the earth surface the temperature is between 10°C and 16°C, in winter this heat can be brought to buildings with pipes.

Continue

- The country with the greatest geothermal energy production is USA, there is the biggest dry steam field, the heaters with an annual capacity of 750MW.

Advantages of Geothermal Energy

1. The operating costs are low.
2. Its not dependent on the weather conditions.
3. Geothermal plant virtually produces no emission.
4. Huge quantity of energy available.
5. Moderate net energy and high efficiency at accessible sites.

Disadvantages of Geothermal Energy

1. Geothermal power stations are expensive to build.
2. The generation of geothermal energy creates noise pollution and releases noxious smells.
3. Can run out of steam.
4. There is always a danger of eruption of volcano.

How Geothermal Energy Works?

1. geothermal energy converts thermal energy to electricity.
2. At a geothermal energy plant, drilling must take place to access hot rocks below the earth's surface.
3. The heat from the rocks is used to convert liquid to steam.
4. The steam is used to turn turbines which are connected by a shaft to a generator, which converts the rotational energy into electrical energy.

Types of Geothermal Energy

- Geothermal energy plants utilize either an open loop or closed loop system to harness geothermal energy so that it can be used for electricity.
 1. **Open Loop System**
 - A. With this type of system, water is pumped down to hot rocks deep in the earth's crust through a pipe.
 - B. Underground, the water leaves the pipe, where heat from the rocks boils it into steam.
 - C. The steam travels through cracks in the rocks and goes back to the surface through pipe which is connected to a turbine.

Continue

- D. After the steam hits the turbine, it is released into the atmosphere.

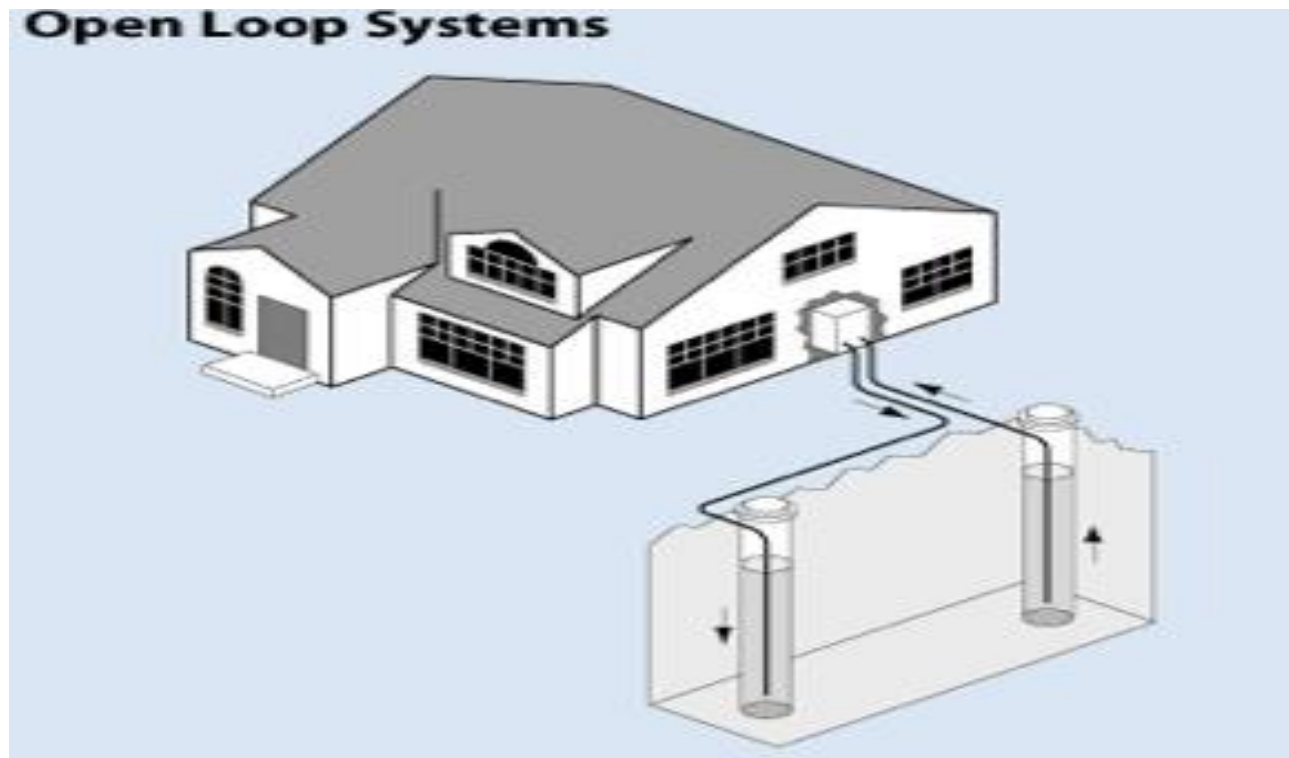

Continue

2. Closed Loop System

- A. The difference between a closed loop and an open loop system is that the steam remains enclosed in pipes through the entire process.
- B. Water, or a liquid with a lower boiling point than water, is piped to hot rocks beneath the surface of the earth where it is converted to steam.
- C. The steam is not released to naturally rise to the surface, as it would be in an open loop. It travels to turn the turbine through a pipe, so it is not exposed to pollutants.

Continue

- D. Instead of being released into the atmosphere, the steam is condensed back into a liquid and pumped back underground for reheating.

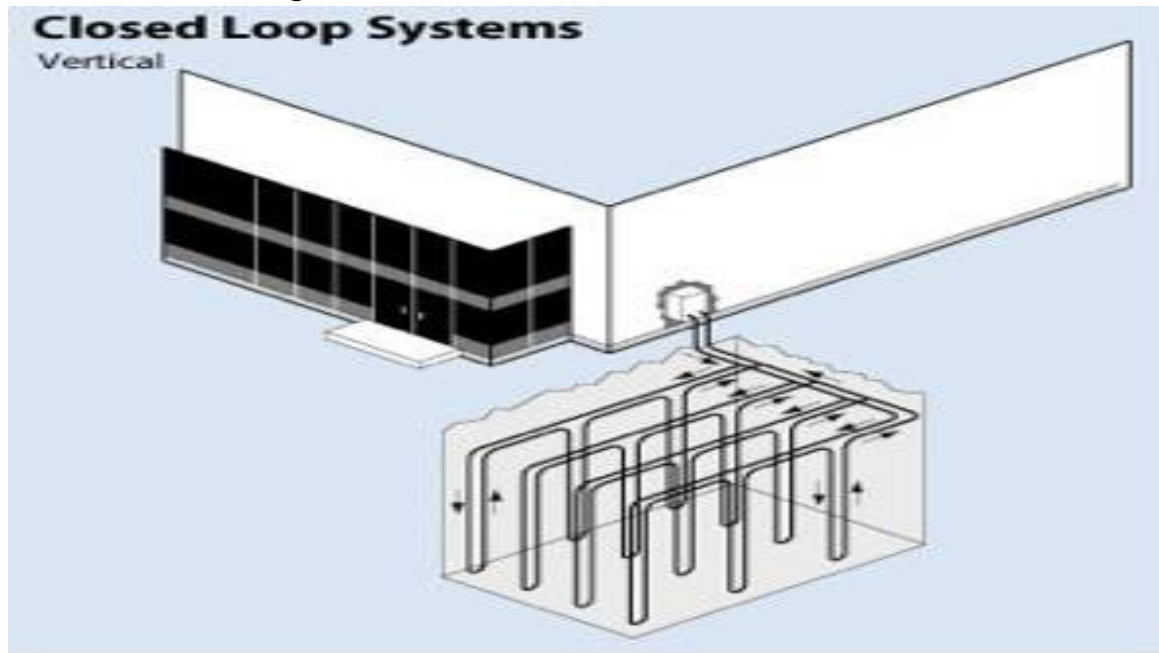

Geothermal Energy Application

1. Electricity Production.

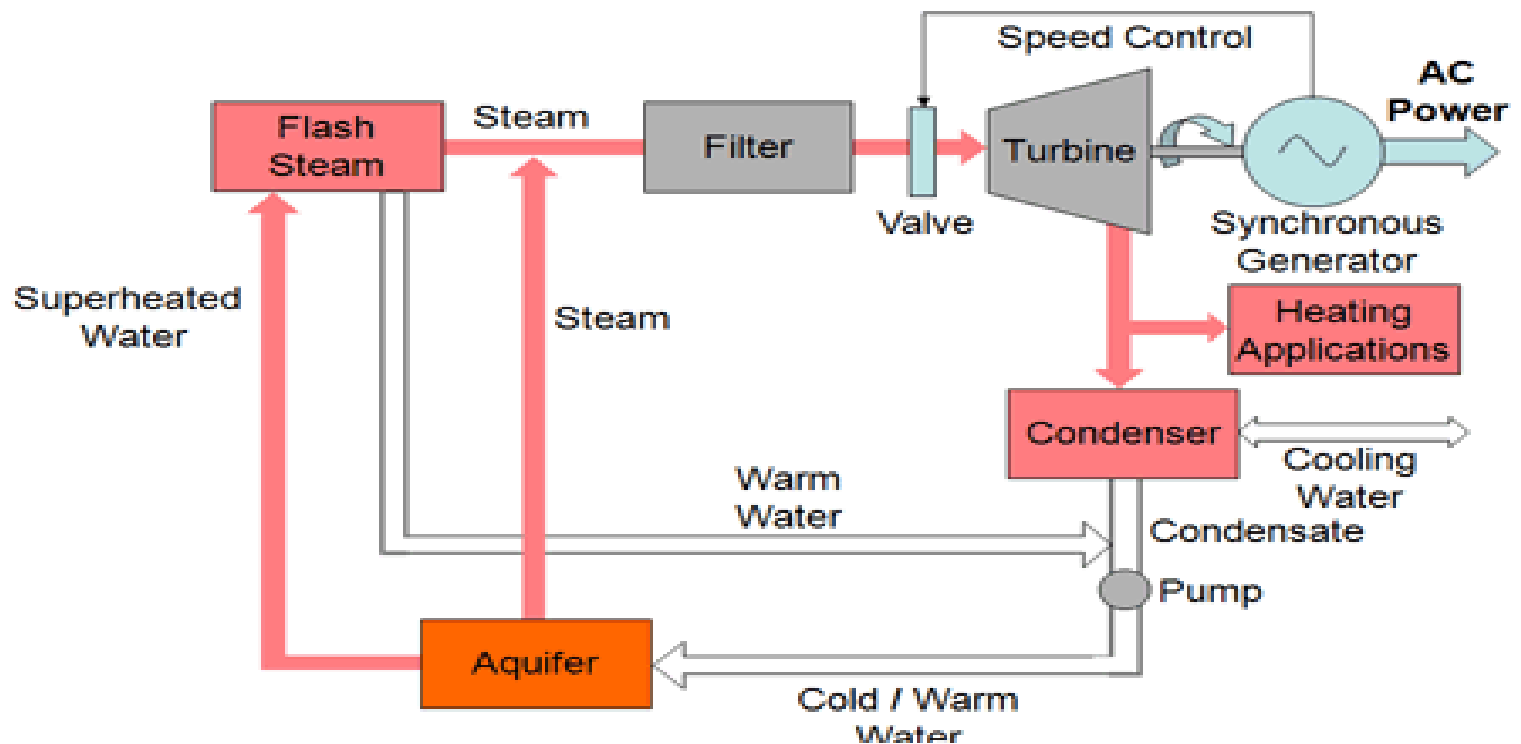

Continue

2. Heating purpose

SUMMER

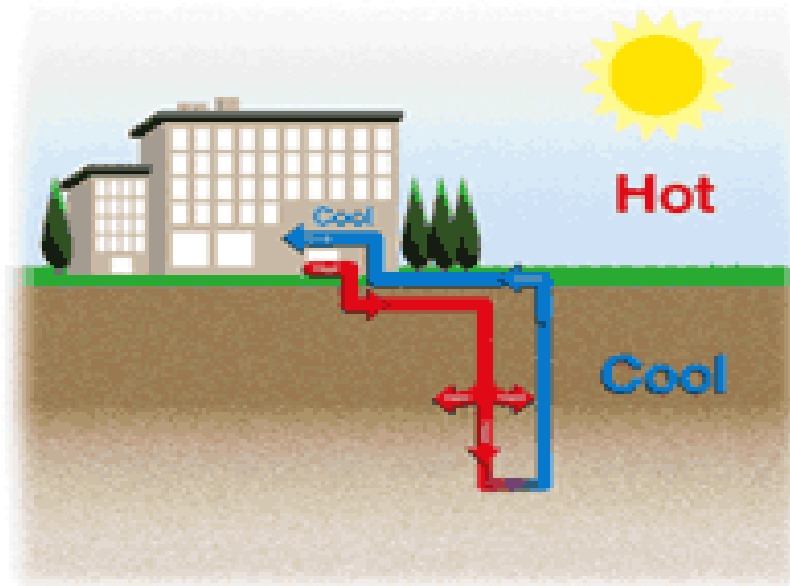

WINTER

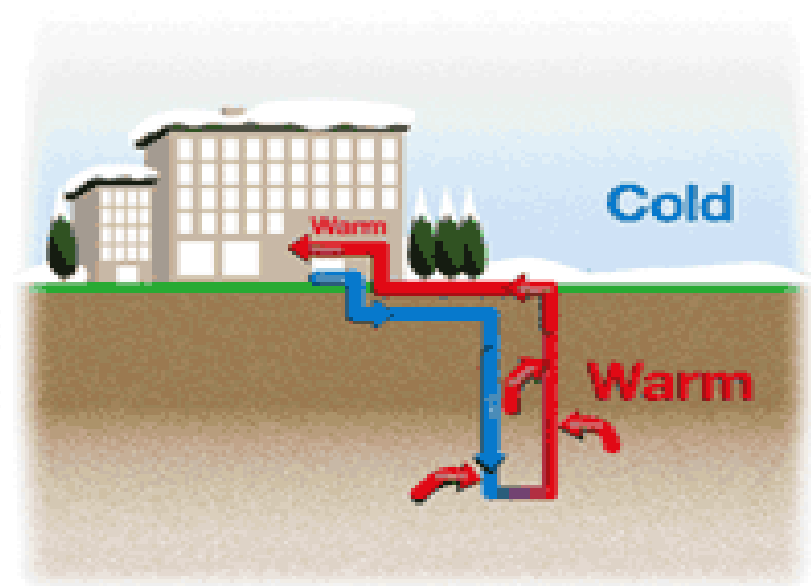

5. Biomass Energy



What is the Biomass Energy?

- Biomass is used to produce Biofuel.
- The most common material for biofuels are photosynthetic plant, a plant specially grown to be used for biofuel manufacturing is known as an **energy crop**.
- Energy which comes from landfill – or rubbish dumps.
- It includes energy from both animal and plant matter.
- Landfill gas is created when the waste you throw away starts rotting in the ground.

Continue

- This gas would normally just seep through the ground and into the atmosphere, contributing to environmental problems, like the greenhouse effect.
- it can be captured and processed to create electricity.
- It is collected, dried, and filtered to get rid of any waste particles.
- It is then fed through pipes to a gas generator that burns the gas to create electricity.

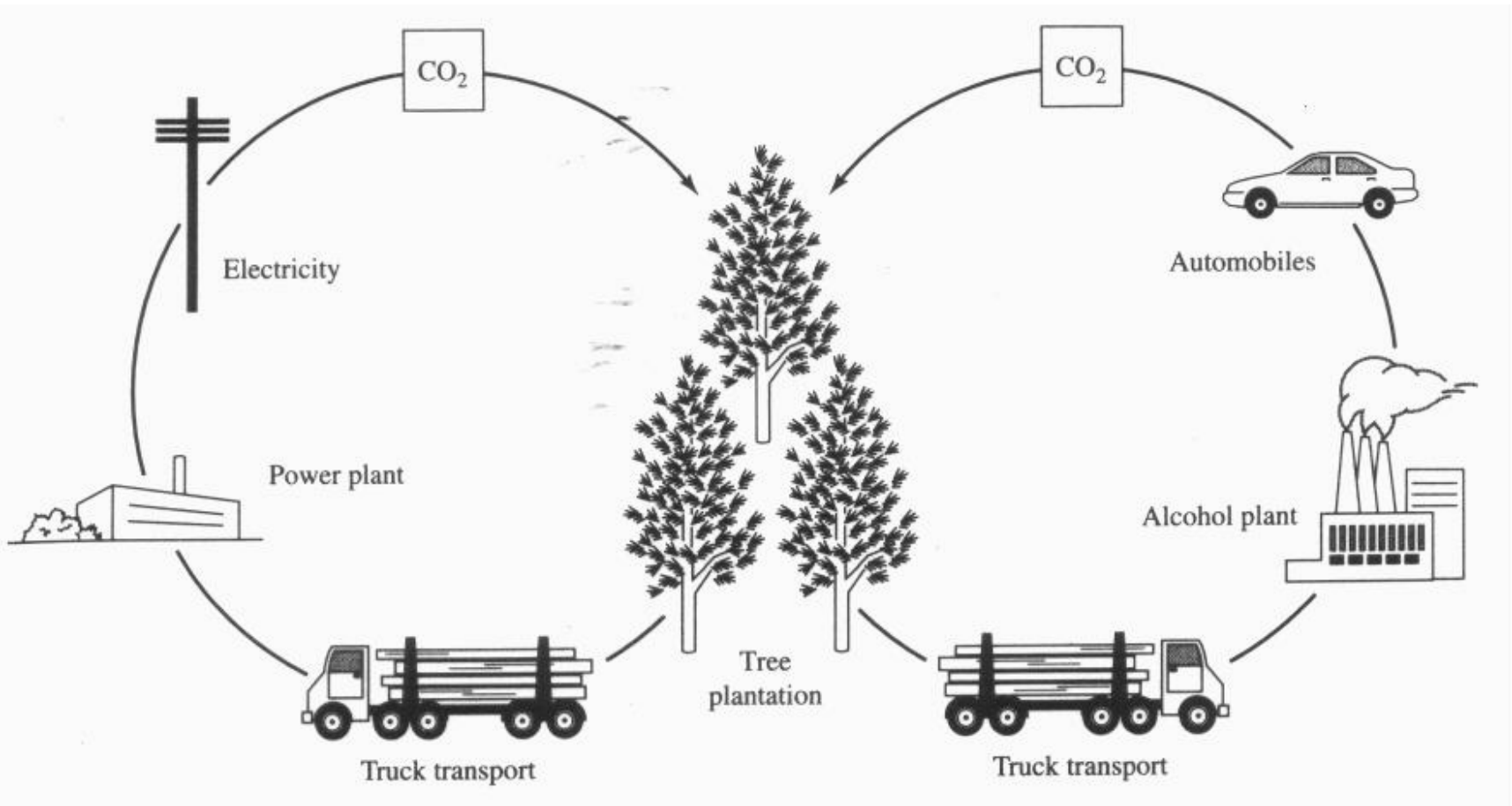

Prof. Mohamed Ahmed Ebrahim

Types of Biomass Energy

1. **Biodiesel**

it's the common and made from oils that extracted from sunflower, soy, animal product.

2. **Biogas**

its produced by the biological breakdown of organic matter in the absence of oxygen. They can be used to generate heat, electric or mechanical energy.

3. **Bio alcohol**

its produced with the help of fermentation inducing microorganisms, that is widely used instead of petrol to power cars in **Brazil**.

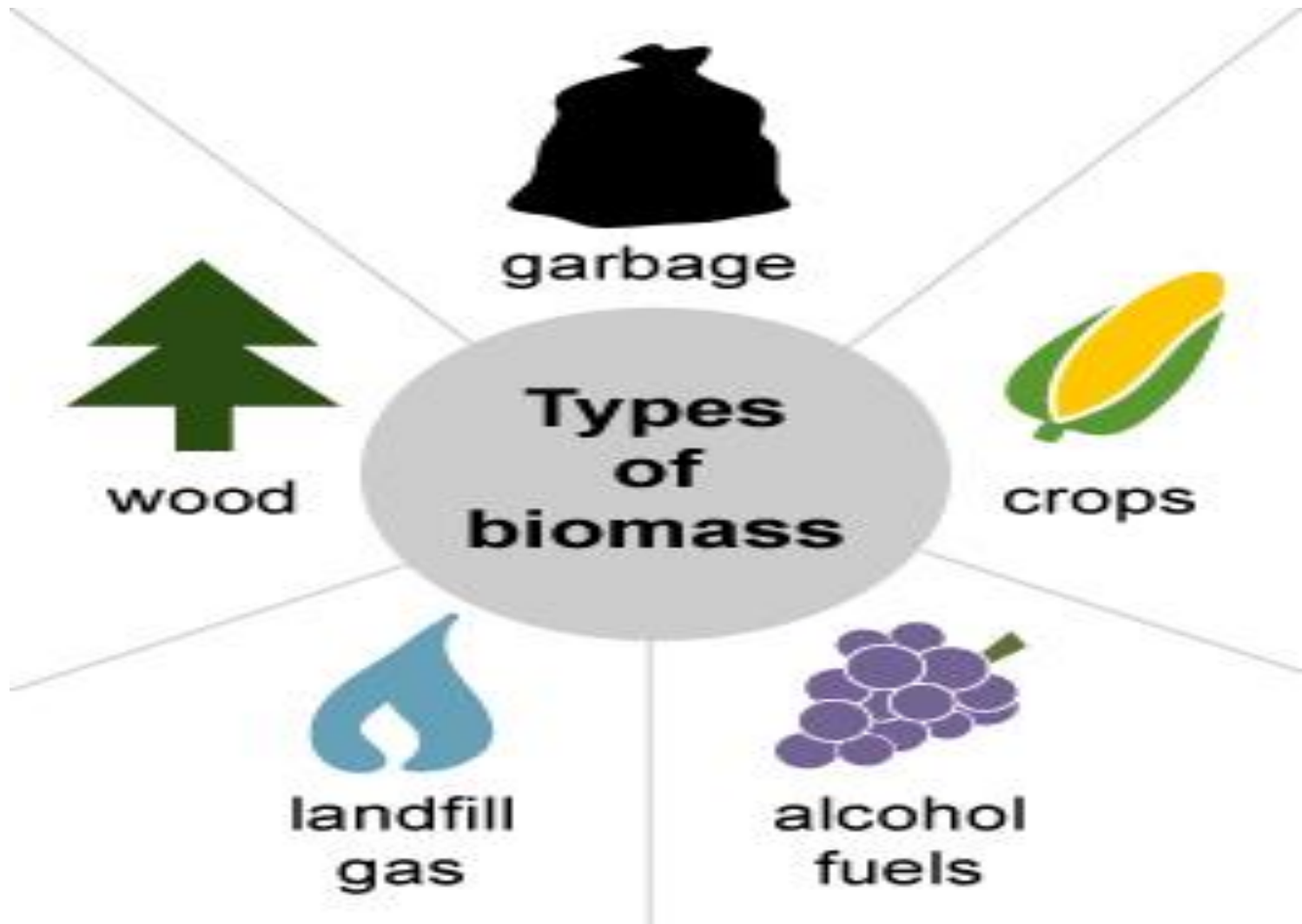

Advantages of Biomass Energy

1. Minimizes overdependence on traditional electricity.
2. Biomass energy sources are bountiful in supply.
3. Reduces amount of waste in landfills.
4. It's carbon neutral(the carbon emitted to the environment from biomass fuels is the amount that was absorbed by plants in their life cycle).
5. Its a renewable form of energy because the organic materials used to produce it are never-ending.

Disadvantages of Biomass Energy

1. It increases methane gases, which are also harmful to the Earth's ozone layer.
2. Uncontrolled biomass production can result in deforestation.
3. Requires a great deal of water.

What is the use of Biomass Energy

1. For producing heat energy:

Any thing from the nature which can burn to heat like (coal, wood, and mustard oil).

2. For producing electricity:

Using method is same as oil. Burn it and get energy either for a state or a house.

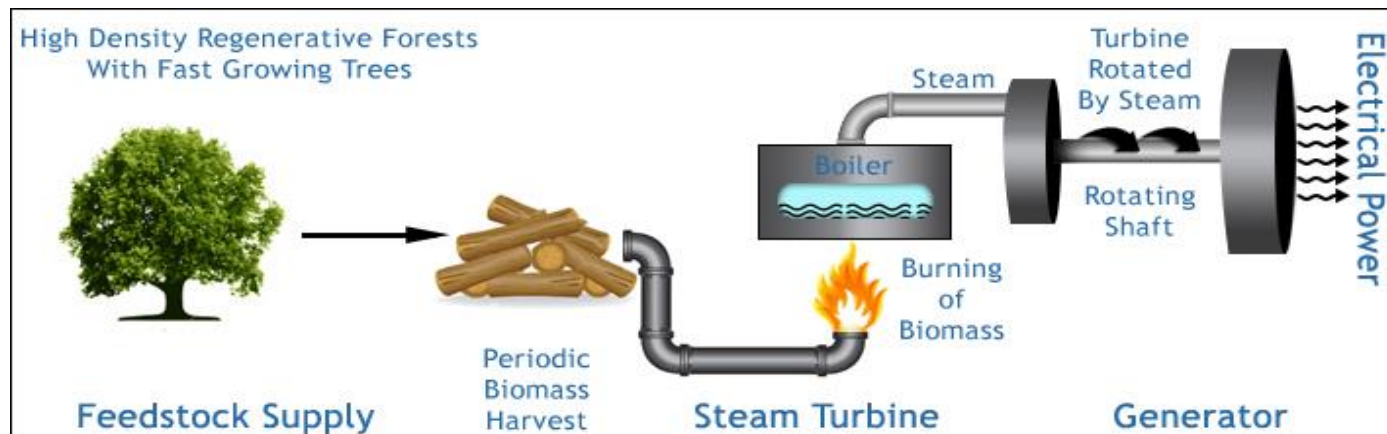



Continue

3. Used in homes for heating or cooking.
4. Industrial applications like lumber mills, naturally produce organic waste.